



Electrolux
PROFESSIONAL

**Modular Cooking Range Line
700XP 400mm Gas Fry Top,
Smooth Brushed Chrome Plate**

ITEM # _____

MODEL # _____

NAME # _____

SIS # _____

AIA # _____



371411 (E71IKTAOMCI)

Half module gas Fry Top with smooth brushed chrome cooking Plate, sloped, thermostatic control, scraper included, Q Mark

Short Form Specification

Item No. _____

To be installed on open base installations or bridging supports. Smooth cooking surface in brushed chrome. Suitable to be used with Natural or LPG gas. Temperature range from 100°C to 280°C. Removable drawer below the cooking surface for the collection of grease and fat. Exterior panels in stainless steel with Scotch Brite finish. One piece pressed work top in 1.5 mm thick stainless steel. Right-angled side edges to allow flush-fitting junction between units.

Main Features

- Unit to be mounted on open base cupboards, bridging supports or cantilever systems.
- Large drain hole on cooking surface permits the draining of fat into large 1 liter collector placed under the cooking surface.
- Large grease collection container available as optional accessory to be installed under top units over open base cupboard.
- Stainless steel high splash guard on the rear and sides of cooking surface. Splash guard can be easily removed for cleaning.
- Piezo spark ignition for added safety.
- Gas appliance supplied for use with natural or LPG gas, conversion jets supplied as standard.
- IPx4 water protection.
- Frontal simmering zone.
- Temperature range from 100° up to 280°C.
- Rough brushed chrome surface is highly resistant to scratches and facilitates cleaning operations at the end of the day.
- Scraper for smooth plate included as standard.
- Suitable for countertop installation.

Construction

- Cooking surface completely smooth.
- Cooking surface 12mm thick brushed chrome for optimum grilling results and ease of use.
- Q Mark model delivered with nozzles for G30-50 mbar.
- All exterior panels in Stainless Steel with Scotch Brite finishing.
- One piece pressed 1.5 mm work top in Stainless steel.
- Model has right-angled side edges to allow flush fitting joints between units, eliminating gaps and possible dirt traps.

Included Accessories

- 1 of Scraper for smooth plate fry PNC 164255 tops

Optional Accessories

- Scraper for smooth plate fry tops PNC 164255
- Junction sealing kit PNC 206086
- Draught diverter, 120 mm diameter PNC 206126
- Matching ring for flue condenser, 120 mm diameter PNC 206127
- Support for bridge type installation, 800mm PNC 206137
- Support for bridge type installation, 1000mm PNC 206138
- Support for bridge type installation, 1200mm PNC 206139
- Support for bridge type installation, 1400mm PNC 206140
- Support for bridge type installation, 1600mm PNC 206141

APPROVAL: _____



Experience the Excellence
www.electroluxprofessional.com



Electrolux
PROFESSIONAL

Modular Cooking Range Line 700XP 400mm Gas Fry Top, Smooth Brushed Chrome Plate

- Support for bridge type installation, 400mm PNC 206154
- Chimney upstand, 400mm PNC 206303
- Right and left side handrails PNC 206307
- Back handrail 800 mm PNC 206308
- Flue condenser for 1/2 module, 120 mm diameter PNC 206310
- Grease/oil kit container for 700 line frytops (half and module) and 900 line frytops (module) PNC 206346
- Chimney grid net, 400mm (700XP/900) PNC 206400
- Kit G.25.3 (NI) gas nozzles for 700 fry tops PNC 206466
- Frontal handrail, 400mm PNC 216046
- Frontal handrail, 800mm PNC 216047
- Frontal handrail, 1200mm PNC 216049
- Frontal handrail, 1600mm PNC 216050
- Large handrail - portioning shelf, 400mm PNC 216185
- Large handrail - portioning shelf, 800mm PNC 216186
- 2 side covering panels for top appliances PNC 216277
- Pressure regulator for gas units PNC 927225



Modular Cooking Range Line
700XP 400mm Gas Fry Top, Smooth Brushed Chrome Plate

The company reserves the right to make modifications to the products without prior notice. All information correct at time of printing.

2025.03.08

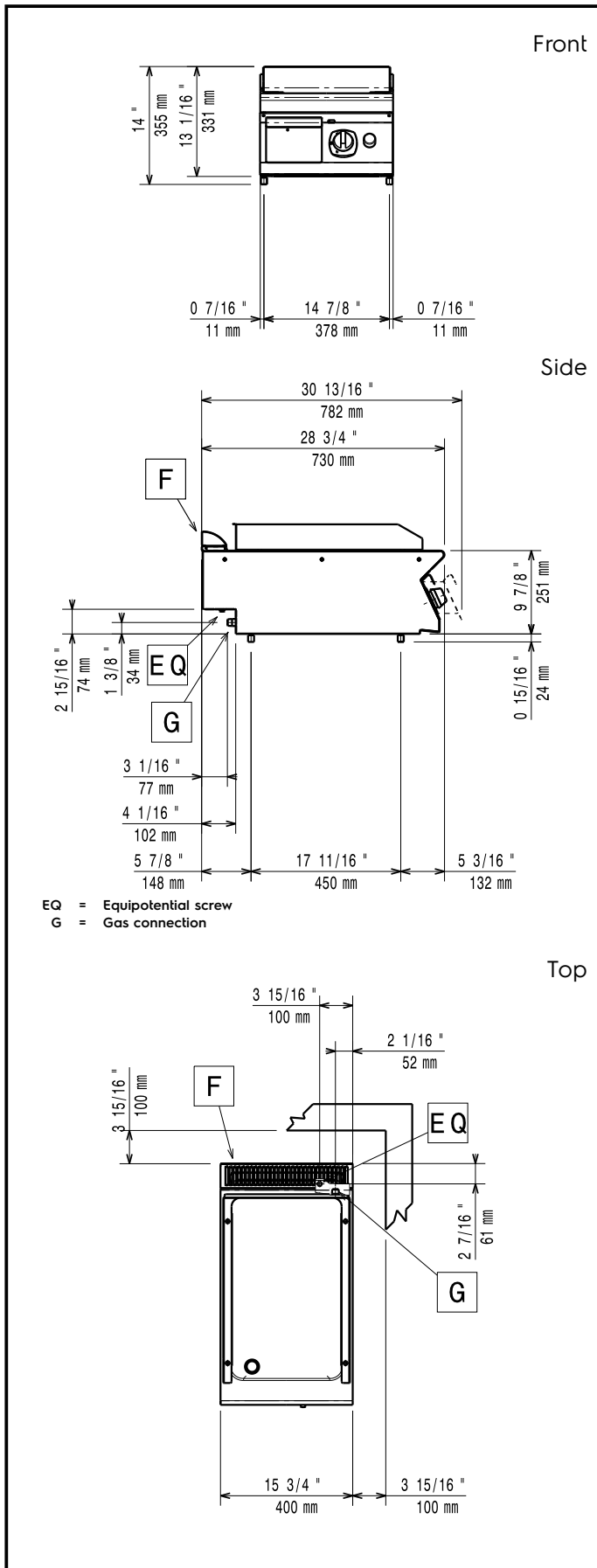

Gas

Gas Power:	7 kW
Standard gas delivery:	G30 - 50 mbar
Gas Type Option:	G31 37 mbar
Gas Inlet:	1/2"

Key Information:

If appliance is set up or next to or against temperature sensitive furniture or similar, a safety gap of approximately 150 mm should be maintained or some form of heat insulation fitted.

Working Temperature MIN:	100 °C
Working Temperature MAX:	280 °C
External dimensions, Width:	400 mm
External dimensions, Depth:	730 mm
External dimensions, Height:	250 mm
Net weight:	40 kg
Shipping weight:	42 kg
Shipping height:	530 mm
Shipping width:	460 mm
Shipping depth:	820 mm
Shipping volume:	0.2 m ³
Cooking surface width:	330 mm
Cooking surface depth:	540 mm